

SG01S-18ISO90

Broadband SiC based UV photodiode A = 0.06 mm²

GENERAL FEATURES

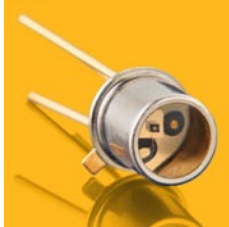

Properties of the SG01S-18ISO90 UV photodiode

- Broadband UVA+UVB+UVC, PTB reported high chip stability
- Active Area A = 0.06 mm²
- TO18 hermetically sealed metal housing, two isolated pins, one additional grounded pin
- 10 mW/cm² peak radiation results a current of approx. 960 nA

About the sglux SiC UV photodiodes

SiC provides the unique property of extreme radiation hardness, near-perfect visible blindness, low dark current, high speed and low noise. These features make SiC the best available material for visible blind semiconductor UV detectors. By standard our SiC detectors can be permanently operated at up to 170°C. A 350°C version is available. The temperature coefficient is also low, < 0.1%/K. Because of the low noise (dark current in the fA range), very low UV irradiance can be measured reliably. Please note that this device needs an appropriate signal transducer (see typical circuit on page 3). The photodiodes are available with seven different active chip areas from 0.06 mm² up to 36 mm². Standard version is broadband UVA-UVB-UVC. Four filtered versions lead to a tighter sensitivity range. All photodiodes have a hermetically sealed metal housing (TO type), either a 5.5 mm diameter (TO18) or 9.2 mm (TO5) Further option is either a 2 pin header (1 isolated, 1 grounded) or a 3 pin header (2 isolated, 1 grounded) as well as the SGO3 series for vacuum UV measurement below 200 nm or the 6H series for enhanced UVA sensitivity range, SMD packaged photodiodes, and photodiodes with circular active are for a more homogenous field of view.

NOMENCLATURE

SG01			
S, D, L, F, XL	nothing, A, B, C, C-LED or E	18, 18ISO90, 18S, 5, 5ISO90	nothing, Lens, D
Chip area	Spectral response	Housing	Special
S 0.06 mm ²	nothing = broadband $\lambda_{\max} = 280 \text{ nm}$ $\lambda_{510\%} = 221 \text{ nm} \dots 358 \text{ nm}$	18 2-pin TO18 housing, h = 5.2 mm, 1 pin isolated, 1 pin grounded	Lens with concentrating lens, TO5 only
D 0.50 mm ²	A = UVA $\lambda_{\max} = 331 \text{ nm}$ $\lambda_{510\%} = 309 \text{ nm} \dots 367 \text{ nm}$	18ISO90 3-pin TO18 housing, h = 5.2 mm, 2 pins isolated, 1 pin grounded	
L 1.00 mm ²	B = UVB $\lambda_{\max} = 280 \text{ nm}$ $\lambda_{510\%} = 231 \text{ nm} \dots 309 \text{ nm}$	18S 2-pin TO18 housing, h = 3.7 mm, 1 pin isolated, 1 pin grounded	D with diffuser for cosine FOV
F 1.82 mm ²	C = UVC $\lambda_{\max} = 275 \text{ nm}$ $\lambda_{510\%} = 225 \text{ nm} \dots 287 \text{ nm}$	5 2-pin TO5 housing, h = 4.3 mm for broadband; h = 6.7 mm for filtered UVA, UVB, UVC, UVI	
XL 7.60 mm ²	E = UV-Index spectral response according to ISO 17166	5ISO90 3-pin TO5 housing, h = 4.2 mm, 2 pins isolated, 1 pin grounded	

SG01S-18IS090

Broadband SiC based UV photodiode A = 0.06 mm²

SPECIFICATIONS

Parameter	Symbol	Value	Unit
Spectral Characteristics			
Typical Responsivity at Peak Wavelength	S_{\max}	0.160	AW ⁻¹
Wavelength of max. Spectral Responsivity	λ_{\max}	280	nm
Responsivity Range ($S=0.1 \cdot S_{\max}$)	–	221 ... 358	nm
Visible Blindness ($S_{\max}/S_{>405\text{nm}}$)	VB	$> 10^{10}$	–
General Characteristics (T=25°C)			
Active Area	A	0.06	mm ²
Dark Current (1V reverse bias)	I_d	0.2	fA
Capacitance	C	15	pF
Short Circuit (10 mW/cm ² at peak)	I_o	960	nA
Temperature Coefficient	T_c	< 0.1	%/K
Maximum Ratings			
Operating Temperature	T_{opt}	-55 ... +170	°C
Storage Temperature	T_{stor}	-55 ... +170	°C
Soldering Temperature (3s)	T_{sold}	260	°C
Reverse Voltage	$V_{R\max}$	20	V

NORMALIZED SPECTRAL RESPONSIVITY

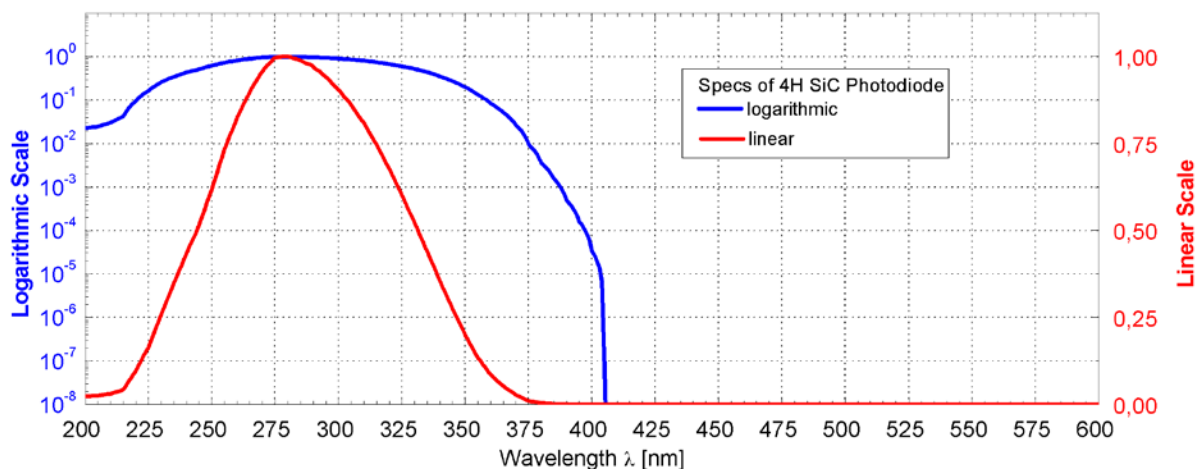

SG01S-18IS090

Broadband SiC based UV photodiode $A = 0.06 \text{ mm}^2$

FIELD OF VIEW

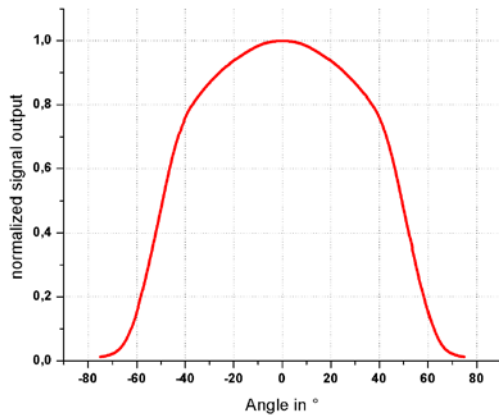

Measurement Setup:

lamp aperture diameter: 10 mm
 distance lamp aperture to second aperture: 17 mm
 second aperture diameter: 10 mm
 distance second aperture to detector: 93 mm

pivot level = top surface of the photodiode window

TYPICAL CIRCUIT



Calculations and Limits:

$$U_a = I_p \times R_f = 0 \dots \sim V_{cc}$$

$U_{a,max}$ depends on load and amplifier type

$R_f = 10k\Omega \dots \sim 10G\Omega$, $C_f \geq 3pF$
 Recommendation: $R_f \times C_f \geq 10^{-3}s$

$$I_{p,max} = U_{a,max} \div R_f$$

$$\text{Bandwidth} = \text{DC} \dots \frac{1}{2\pi \times R_f \times C_f}$$

Example:

$$I_p = 20nA, R_f = 100M\Omega, C_f = 100pF$$

$$U_a = 20 \times 10^{-9}A \times 100 \times 10^6\Omega = 2V$$

DRAWINGS

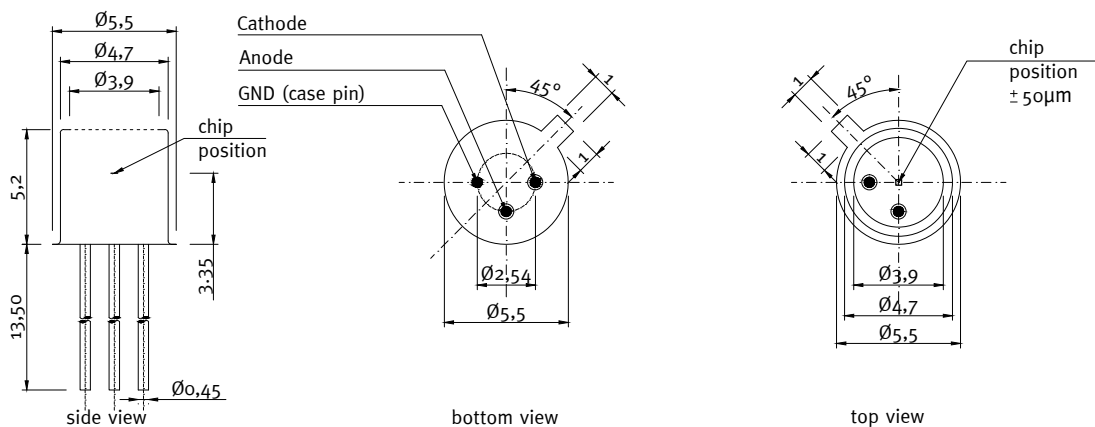

SG01S-18ISO90

Broadband SiC based UV photodiode A = 0.06 mm²

APPLICATION NOTE FOR PHOTODIODES

For correct reading of the photodiode the current (and NOT the voltage) must be analyzed. This requires a short circuiting of the photodiode. Usual approaches are using a **Picoamperemeter** or a **transimpedance signal transducer** circuit as shown on page 3.

UPGRADE TO A TOCON OR A PROBE



TOCONs = UV sensors with integrated signal transducer

- SiC based UV hybrid detector with signal transducer (0-5V output), no additional amplifier needed, direct connection to controller, voltmeter, etc.
- Measures irradiance from 1.8 pW/cm² up to 18 W/cm²
- UV broadband, UVA, UVB, UVC or Erythema measurements

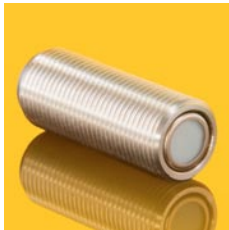

Miniature housing with M12x1 thread for the TOCON series

- Optional feature for all TOCON detectors
- Robust stainless steel M12x1 thread body, supply voltage 7...24 V
- Integrated sensor connector (Binder 4-Pin plug) with 2m connector cable
- Easy to mount and connect, increased EMC safety

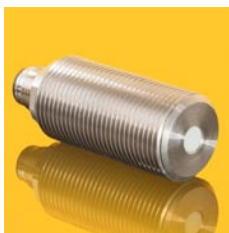

UV probes

- Different housings e.g. with cosine response or water pressure proof
- Different electronic outputs configurable (voltage, current loop, USB, Modbus, CAN)
- Good EMC safety for industrial applications

CALIBRATION SERVICE

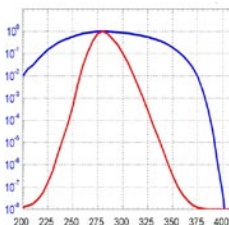

- PTB traceable calibrations and measurements:
- Calibration of sensors for irradiance measurements
- Calibration of UV sensors on discrete wavelengths
- Determination of a specific spectral sensor responsivity